

**ebm-papst St. Georgen GmbH & Co. KG**

Hermann-Papst-Str. 1
 D-78112 St. Georgen
 Phone +49 (0) 7724 81-0
 Fax +49 (0) 7724 81-1309
 info2@de.ebmpapst.com
 www.ebmpapst.com

Nominal data

Type	4806 Z	
Phase		1~
Nominal voltage	VAC	115
Frequency	Hz	60
Speed	min ⁻¹	1800
Power input	W	12.0
Min. ambient temperature	°C	-40
Max. ambient temperature	°C	70
Air flow	m ³ /h	105
Sound power level	B	4.1
Sound pressure level	dB(A)	28

ml = Max. load · me = Max. efficiency · fa = Running at free air · cs = Customer specs · cu = Customer unit
 Subject to alterations



Technical features

Mass	0.540 kg
Dimensions	119 x 119 x 38 mm
Material of impeller	Sheet steel, coated in black
Housing material	Die-cast aluminium
Direction of air flow	Exhaust over struts
Direction of rotation	Right, looking at rotor
Bearing	Ball bearings
Lifetime L10 at 40 °C	52500 h
Lifetime L10 at maximum temperature	17500 h
Connection line	2 flat connectors 2.8 x 0.5 mm. Housing with grounding lug for M4 x 8.
Motor protection	Protected from overload using impedance protection
Approval	VDE, CSA, UL, CE
Option	Available with electrical terminals on single strands that are 310 mm in length.



Product drawing

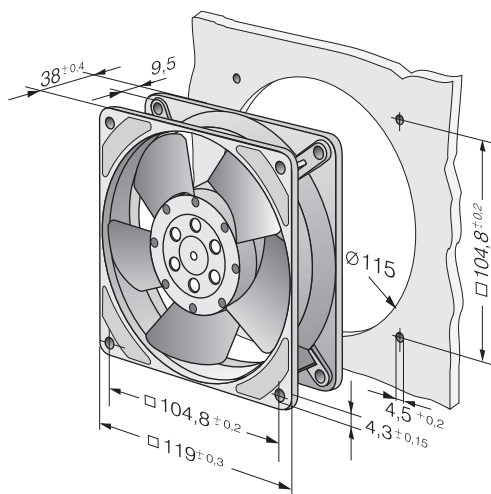

Charts: Air flow

